

**RICOH®**

# **PRIPORT VT1730**

**Operating Instructions**

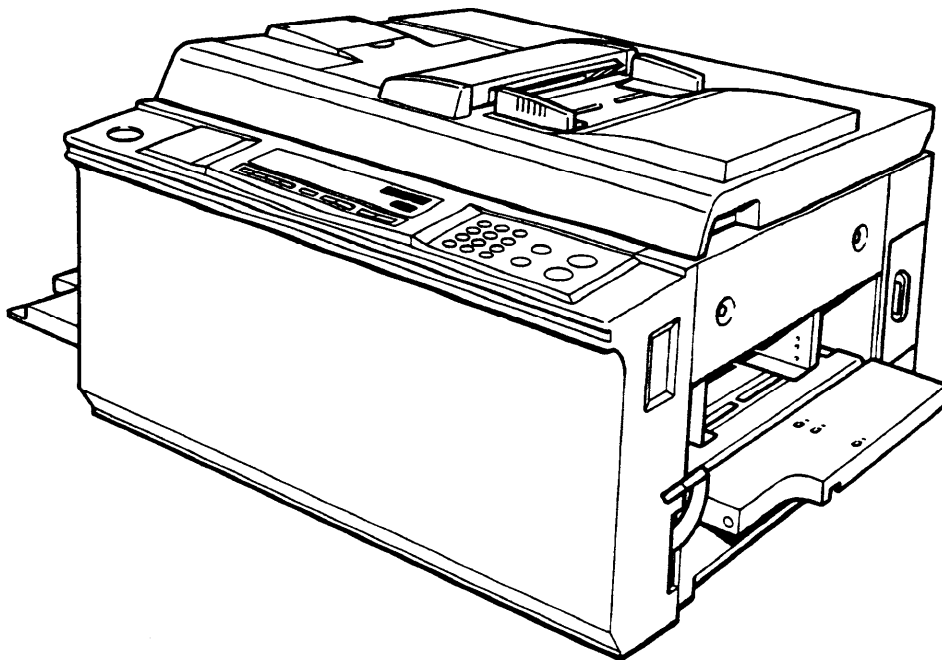

# MAJOR COMPONENTS

## Machine Exterior

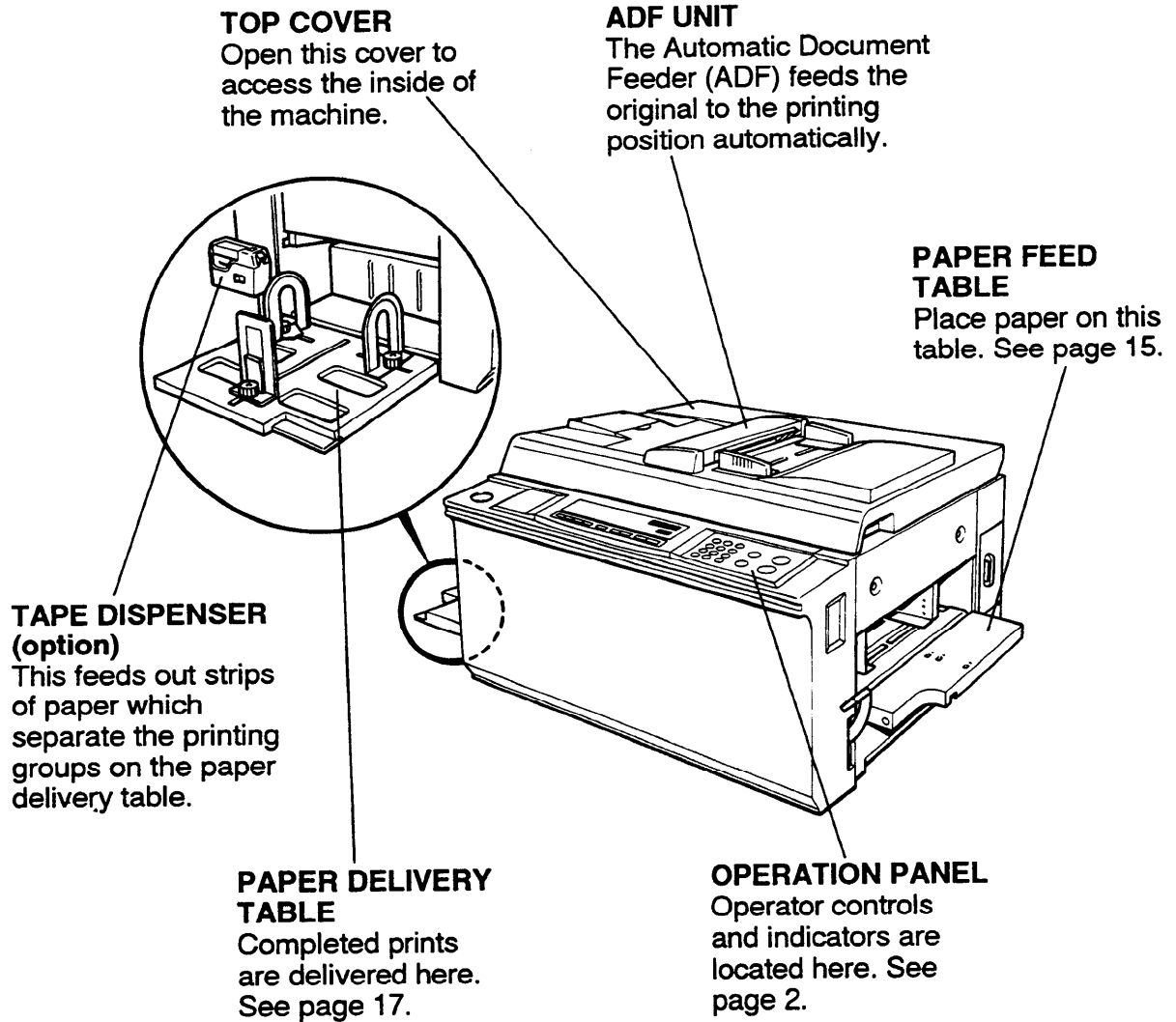

# Operation Panel

## - Keys -

### IMAGE MODE KEY

Press to select the Line mode or Photo mode in accordance with the type and quality of the original. See page 35.

### SPEED KEY

Press to adjust the rotation speed of the machine in accordance with the type of image and printing paper. See page 27 and 28.

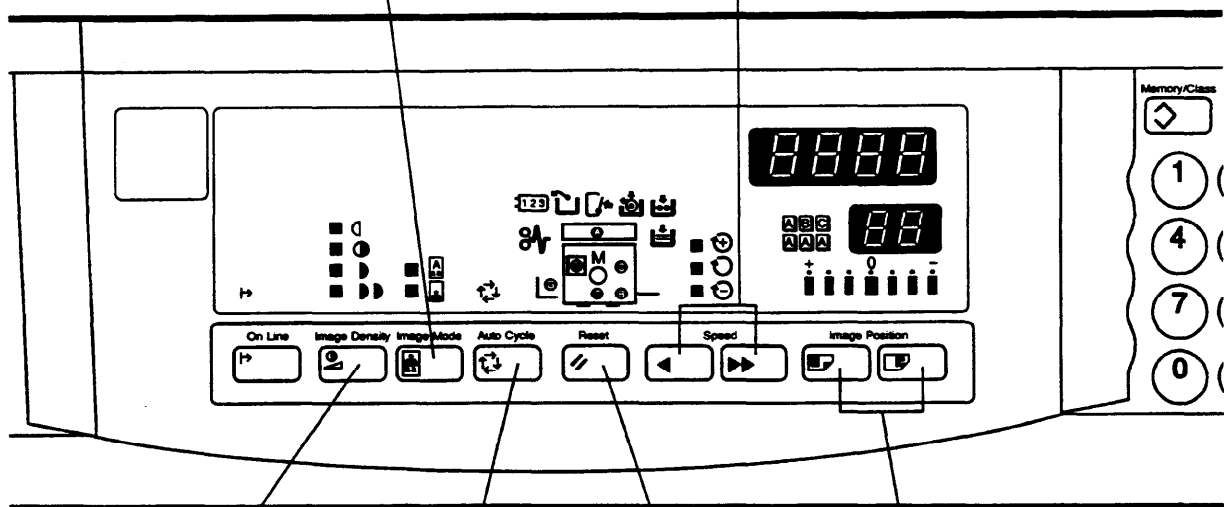

### IMAGE DENSITY KEY

Press to make prints darker or lighter. See page 27.

### AUTO CYCLE KEY

Use to automatically process masters and make prints. See page 30.

### RESET KEY

Press to reset error indicators.

### IMAGE POSITION KEY

Press to shift the image forwards or backwards on the print paper. See page 24.

**MEMORY/CLASS KEY**

Press to select group printing. See page 31 and 33.

**NUMBER KEYS**

Press to enter the number of prints.

**STOP KEY**

Press to stop the machine. The machine will continue printing when the **Print Start** key is pressed. If you stop making a master, the "□/~+ A" indicators will blink and the machine will not continue making the master when the **Master Making** key is pressed.

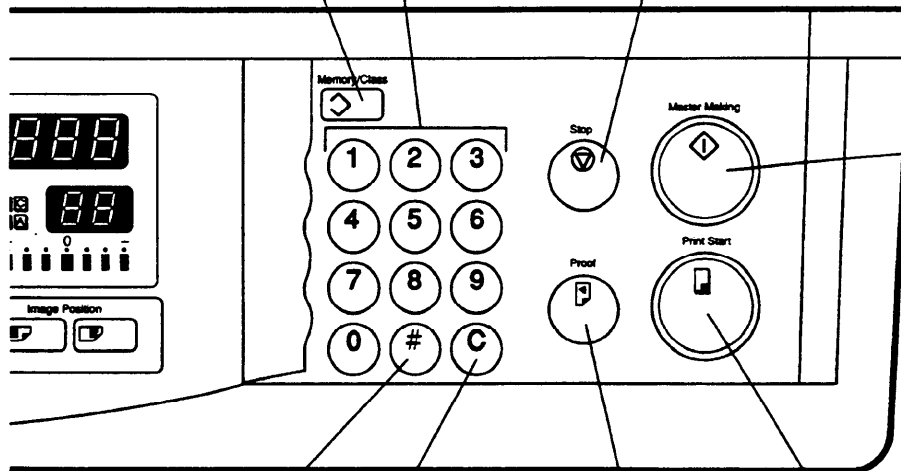

**MASTER MAKING KEY**

Press to make a master.

**ENTER KEY**  
Press to input information into the memory.

**CLEAR KEY**  
Press to change the number that is set in the counter.

**PROOF KEY**  
Press to make trial prints or extra prints.

**PRINT START KEY**  
Press to start printing.

---

# INSTALLATION REQUIREMENTS

## Machine Environment

The installation location should be carefully chosen because environmental conditions greatly affect the performance of the machine.

### Optimum environmental conditions

- Temperature: 10 ~ 30 °C, 50 ~ 86 °F
- Humidity: 20 ~ 90 % RH
- On a strong and level base (for example, a sturdy desk).
- The machine must be level within 5 mm, 1/5" both front to rear and left to right.

## Environments To Avoid

- Locations exposed to direct sunlight or strong light (more than 1,500 lux).
- Locations directly exposed to cool air from an air conditioner or to heat from a heater.  
(Sudden temperature changes from low to high or vice versa may cause condensation within the machine.)
- Dusty areas.
- Areas with corrosive gases.

## Power Connection

- Securely connect the power cord to a dedicated 120V,60Hz power source which supplies more than 2.4A.
- Make sure the plug is firmly inserted into the outlet.
- Avoid multiwiring.
- Do not pinch the power cord.
- Make sure that the wall outlet is near the machine and easily accessible.
- Voltage must not fluctuate more than 10 %.

## Access To The Machine

Place the machine near a power source, providing clearance as shown below.

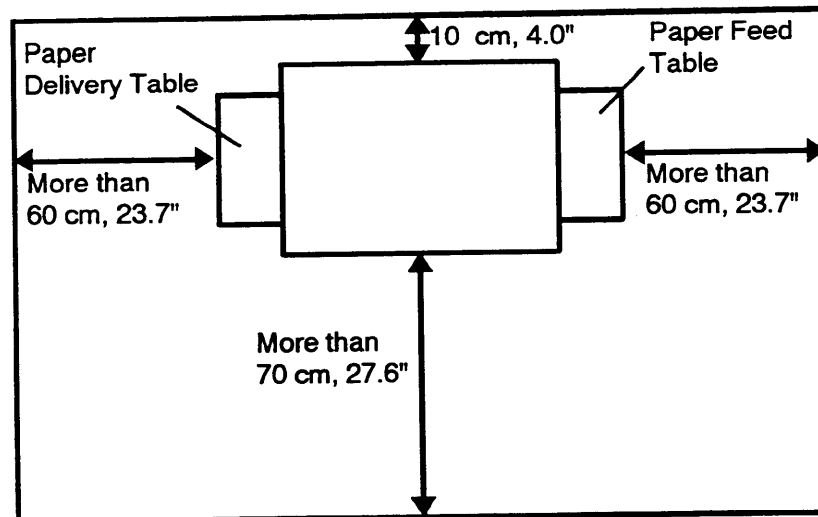

---

# SUPPLYING THE MASTER ROLL, INK, AND TAPE

## Supplying The Master Roll

*Caution: When you open the top cover, make sure that there are no originals on the top cover.*

*Caution: If you drop something, such as a clip, inside the machine, remove it before continuing. If you cannot find what you have dropped or if you are unable to remove it from the machine, contact your service representative.*

1. Insert both spools into a new master roll.

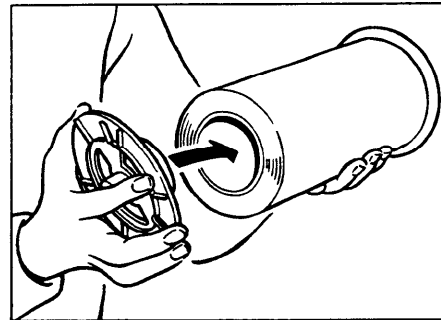

2. Open the top cover.

*Caution: When you open or close the top cover, be careful not to pinch your fingers between the top cover and the back cover.*

*Caution: When you open or close the top cover, be careful not to hit your head or hands against the switch actuator of the top cover.*

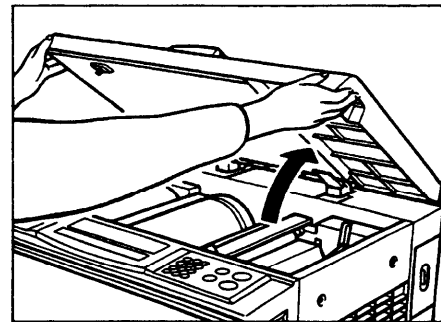

3. Position the new master roll as shown in the illustration.

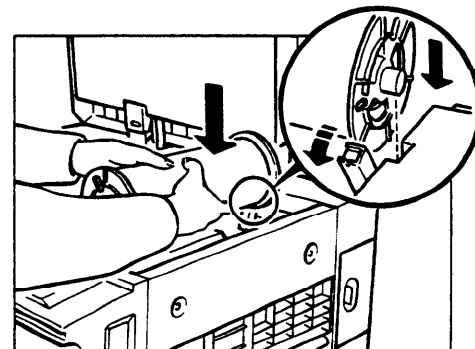

4. Lift the pressure release lever in the direction of the arrow to release the feed roller pressure.

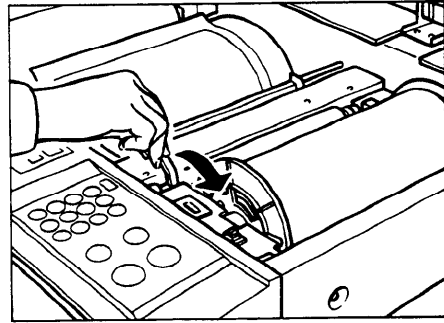

5. Insert the leading edge of the master roll under the feed roller.

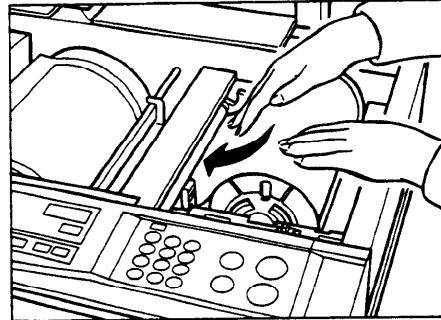

6. Return the pressure release lever to its original position.

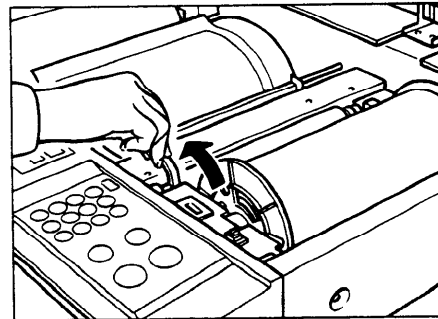

7. Turn on the main switch.

- The main switch is located at the left side of the operation panel.

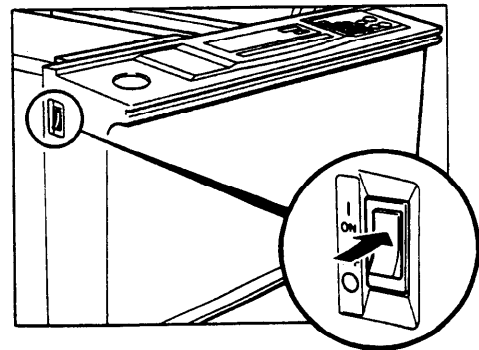

8. Press the master cut button to cut the leading edge of the master roll.

**Caution:** When the master cut button is pressed, the master roll will rotate. Do not touch the master roll.

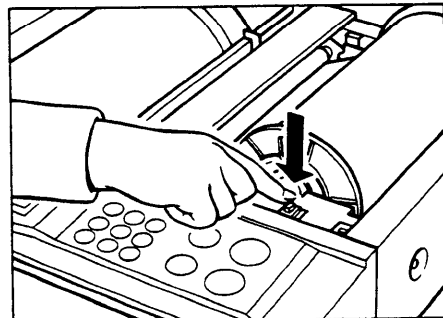



9. Remove the cut-off portion of the master roll.

- Remove the cut-off master paper completely to prevent master misfeed.
- If the master is slack after rotating, move the pressure release lever several times to take up the slack.

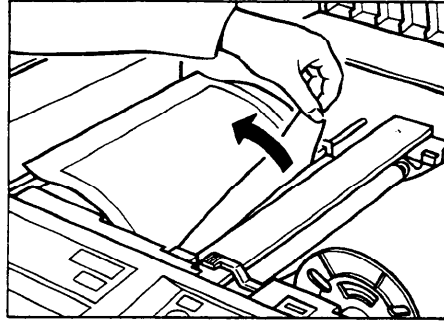

10. Close the top cover.

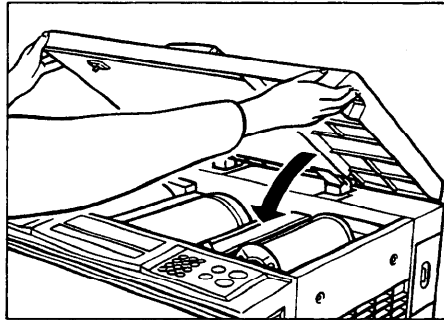

# Supplying Ink

1. Open the ink cover.

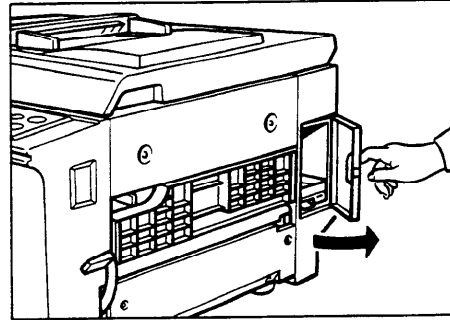

2. Press down the release lever (green tab [A]). The ink pack holder slides out part way.

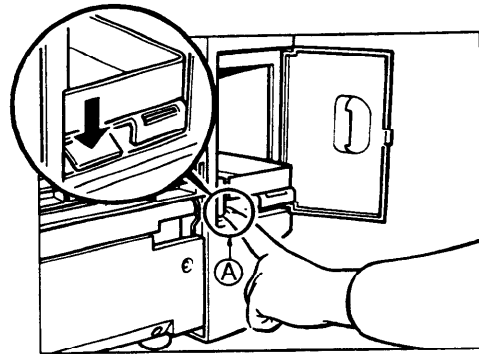

3. Pull out the ink pack holder as shown.

**Caution:** Take your finger off the release lever while pulling out the ink pack holder. You may be injured by the edge of the holder.

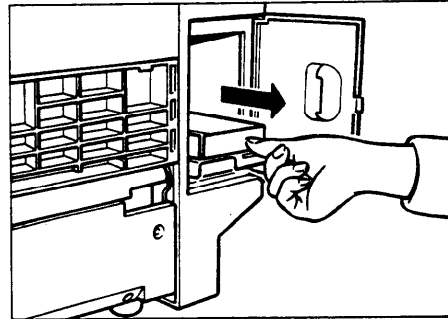

4. Remove the cap of the new ink pack.

- Do not remove the seal from the spout of the ink pack.

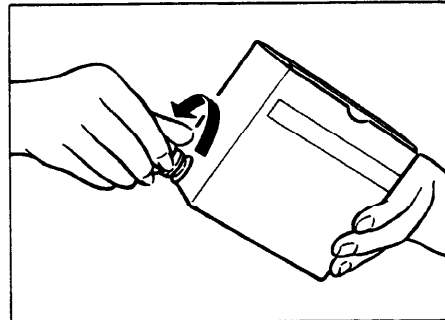

5. Install a ink pack as shown in the figure.

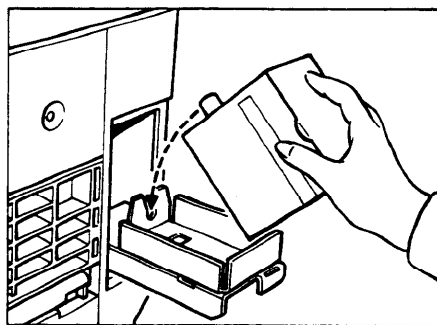

5. Slide in the ink pack holder.

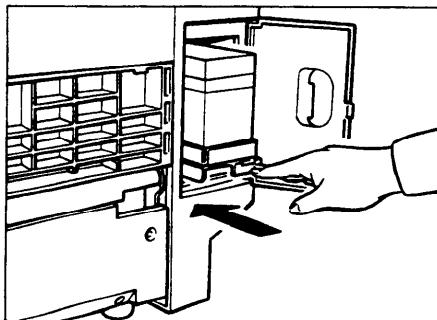

6. Press the setting lever (green tab [B]) until it clicks.

- If the setting lever is not pressed properly, ink will not be supplied from the ink pack to the machine.

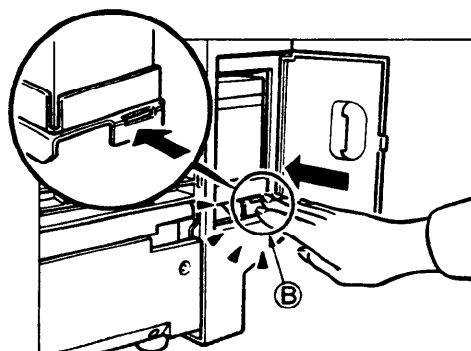

7. Close the ink cover.

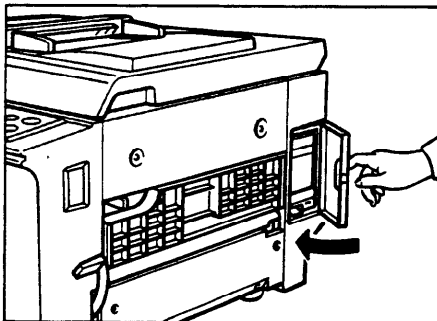

## Supplying Tape For The Tape Dispenser (Option)

☐ Make sure that the main switch is turned on and the tape power switch is off.

1. Open the cover of the tape dispenser.

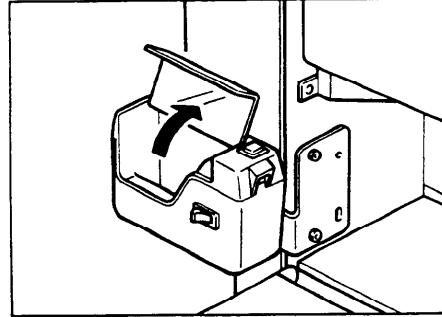

2. Put the roll in the dispenser.

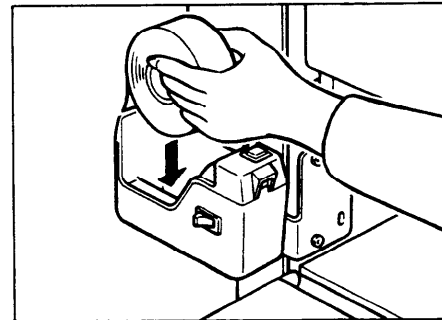

3. Feed the leading edge of the roll into the dispensing slot until it stops.

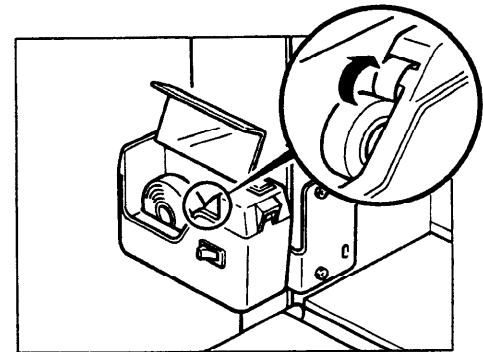

4. Turn on the power switch of the tape dispenser.

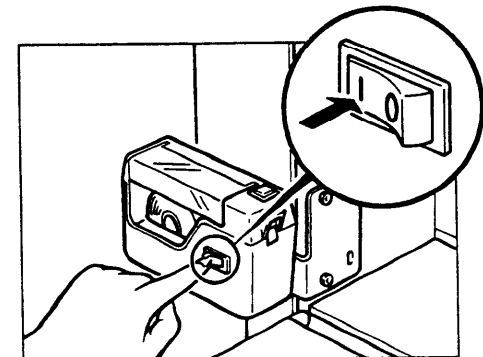

5. Press the manual cut button to trim off the leading edge of the tape.

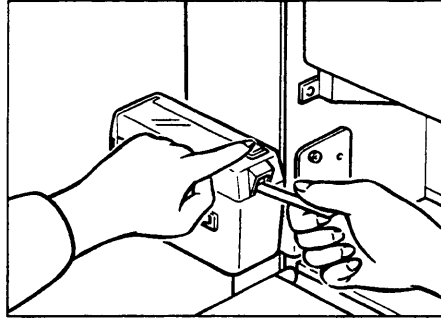

# OPERATION

## Cautions For Printing Paper

Only use printing paper that meets the following specifications:

Size: Max.: 216 mm x 356 mm, 8.5" x 14.0"  
Min.: 90 mm x 140 mm, 3.5" x 5.5"

Weight: 70 g/m<sup>2</sup> ~ 200 g/m<sup>2</sup>, 18.6 lb ~ 53.2 lb

Print Area: 210 mm x 349.6 mm, 8.3" x 13.8" or less

### Cautions:

- Avoid using the following kinds of paper:
  - ⇒ Roughly-cut paper
  - ⇒ Paper of different thicknesses in the same stack
  - ⇒ Buckled or curled paper
  - ⇒ Short grained paper
  - ⇒ Paper of low stiffness
  - ⇒ Dusty paper
- Correct curls in the paper before setting it in the machine. When you cannot correct the paper curl, stack the paper with the curl face down. Otherwise the paper may wrap around the drum or stains may appear.
- Store paper where it will not curl or absorb moisture. Use paper soon after it is unpacked.
- Avoid using the top and bottom sheets of a new paper pack to prevent paper misfeeds (multiple feeding).
- When thick paper is used, the paper tends not to be delivered properly if it is curled or if the printing speed is at the lowest setting.
- Only use paper where the leading edge has two right angle corners, as shown below.

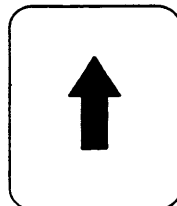

Not OK.

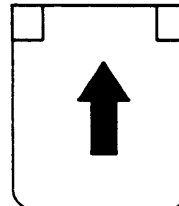

OK.

# Cautions When Using The Document Feeder

Only use originals that meet the following specifications:

Size: Max.: 216 mm x 356 mm, 8.5" x 14.0"  
Min.: 90 mm x 140 mm, 3.5" x 5.5"

Weight: 64 g/m<sup>2</sup> ~ 104.7 g/m<sup>2</sup>, 17.0 lb ~ 27.9 lb

## Cautions:

- Remove paper clips or staples from the originals.
- If you use paste-up originals, make sure the pasted parts are adhered firmly to the base sheet. If the thickness of the paste-up original is more than 0.1 mm, 1/250", a shadow may be printed on the paper.
- Correct curled or bent originals to prevent misfeeds.
- If you use curled or folded originals, the image on the prints will be distorted, especially for straight lines. The machine cannot correct curls or folds in originals.
- If there is a large solid fill image on the leading edge of the original, paper misfeeds tend to occur. In that case, shift the image position backward with the **Image Position** key (See page 24).
- For the following types of originals, make a copy and use the copy as an original.
  - Carbon coated originals
  - Bent or damaged originals
  - Originals with glue on them
  - Originals with binding holes
- The first 5 mm, 1/5" of the leading edge and the last 1 mm, 1/25" of the trailing edge cannot be printed. Make sure the leading edge margin is at least 5 mm, 1/5" and the trailing edge margin is at least 1 mm, 1/25".

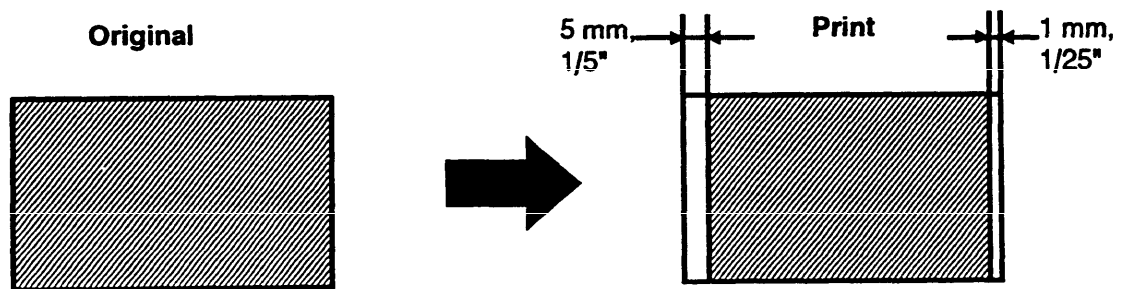

# Preparation For Printing

- When you load thick and small paper, see page 16.

## Loading paper

1. Open the paper feed table carefully.
2. Adjust the paper feed side plates to match the paper size.
3. Press down the feed roller pressure lever.

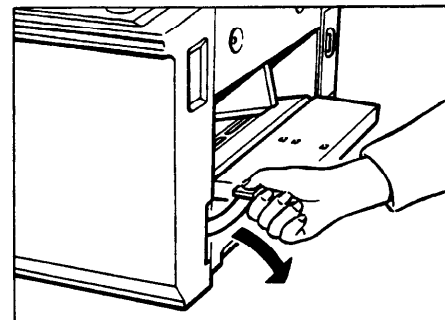
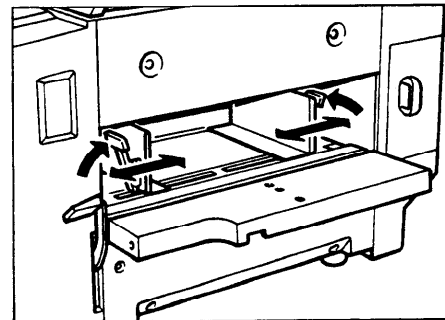
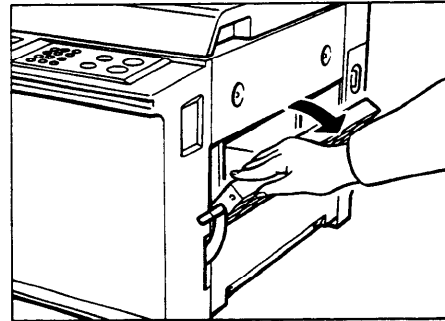



4. Place the paper on the paper feed table.

- Make sure every sheet in the stack is set evenly. This helps prevent paper skewing.
- Make sure the leading edge of the stack is in full contact with the front board.
- 500 sheets of paper can be loaded at a time. If you load more than 500 sheets, paper may not be fed properly.
- Do not stack paper over the paper feed side plates.

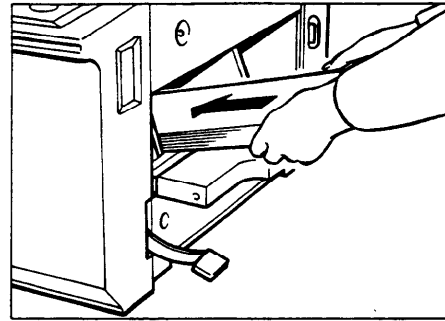

5. Lift the feed roller pressure lever.

*Caution: Be careful not to catch your finger between the lever and the side panel.*

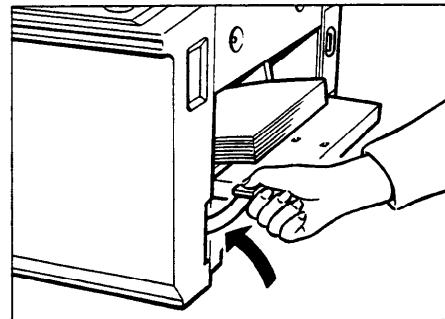

6. Make sure that the paper feed side plates contact the paper gently.

- The paper feed side plates should be parallel to the sides of the paper stack, otherwise the paper might not be fed correctly.

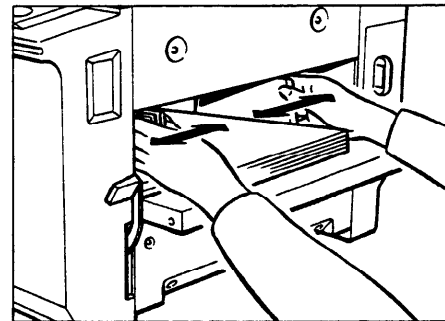

**Printing on thick and small paper**

Set the side pads before adjusting the paper feed side plates to match the paper size.

Thick and small paper:  
 Heavier than 150 g/m<sup>2</sup>, 39.9 lb  
 Smaller than 210 x 150 mm,  
 8.3" x 5.9"

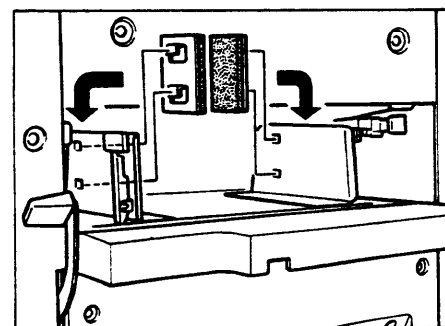

## Setting up the paper delivery table

1. Open the paper delivery table.

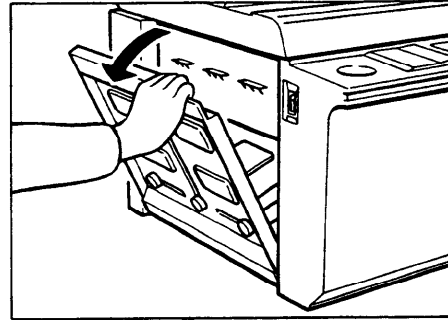

2. Move the paper delivery end plate to match the print paper size.

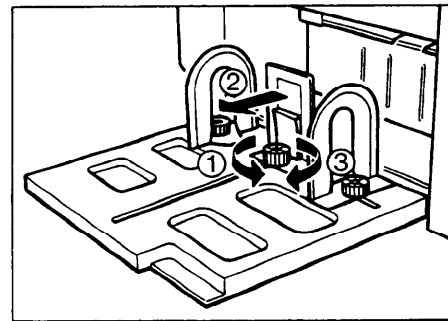

3. Move the paper delivery side plates to match the print paper size.

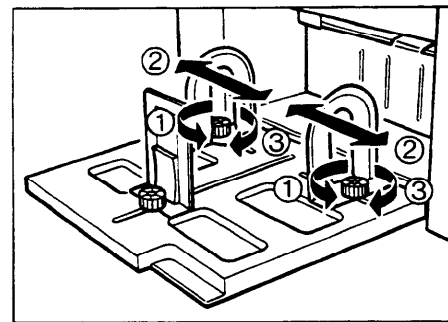

4. Adjust the paper delivery rollers to match the paper size.

- If you position the paper delivery rollers on the print area, each roller will make a line on the paper.
- You should leave margins of more than 5 mm, 1/5" on the right and left sides of the paper because the rollers track those areas.
- The paper delivery rollers may not feed properly and a misfeed may occur if the print contains a large solid fill image. In such cases, leave margins of approximately 10 mm, 2/5" on both edges and move the rollers further away from the edges.

**Caution:** Do not touch the paper delivery rollers while the machine is operating, or the machine will be damaged.

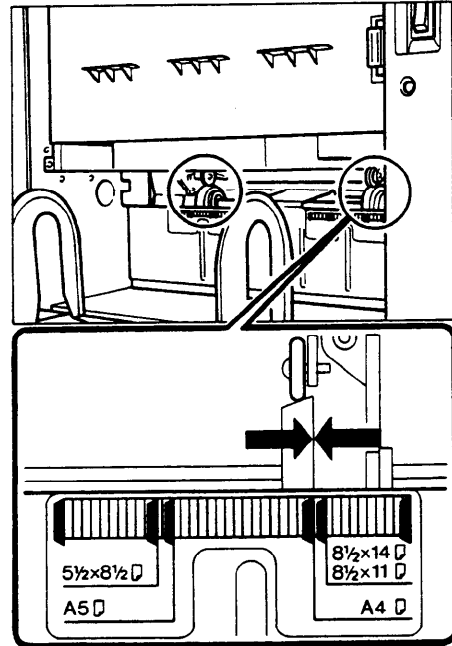

## Standard Printing

- The leading edge margin of the paper must be more than 5 mm, 1/5", because if there is no margin on the paper, the paper might be misfed, or might become dirty. If there is no margin on the original, adjust the image position by pressing the **Image Position** key. See page 24.
- Set the original straight. If you set the original obliquely, the original will be fed obliquely and the original image may be distorted.

### Important

**The stack should not exceed 6 sheets of normal thickness paper.**

*Caution: While printing, do not move the paper delivery rollers. Otherwise, the drum may be damaged.*

1. Adjust the original guides to the size of the original.

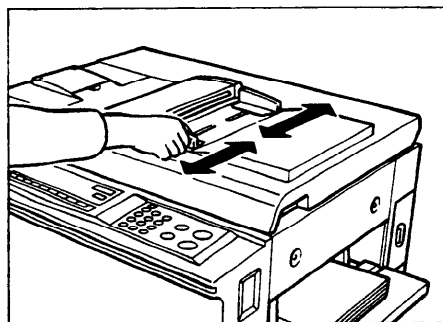

2. Insert the original face down in the ADF until it stops.

- Do not insert different size originals at the same time.
- The fed original may not be delivered completely from the ADF until the next original is fed.

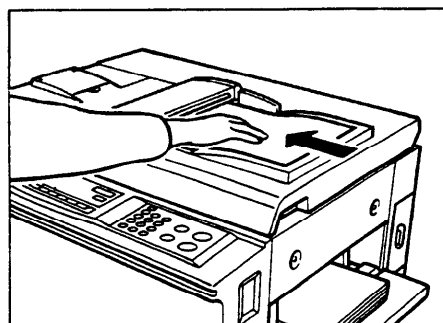

3. Using the **Number** keys, enter the number of prints required.

- Up to 9999 prints can be entered at one time.
- To change the number entered, press the **Clear** key and then enter the new number.

When you use larger than A4 or 8 1/2" x 11" size paper, set the original tray extender.

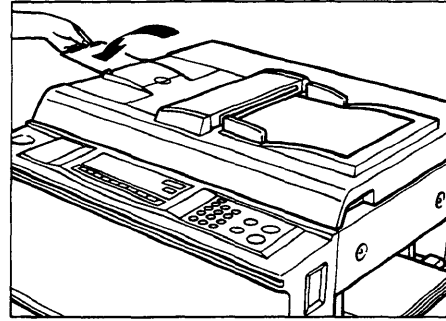

4. Press the **Master Making** key.

- The original is fed, and a trial print is delivered to the paper delivery table.

5. Press the **Proof** key and check the image density and the image position. Use the **Proof** key until the image density is stabilized.

- If the image position is not correct, adjust it using the **Image Position** key (See page 24) or the side plate fine adjustment dial (See page 25).

6. Press the **Print Start** key.

- After printing is completed, the same number of prints is automatically set for the next job.
- If the next original has been placed in the original table before the machine stops, that original is fed automatically and a new master is made.

If you want to stop the machine during a print run, press the **Stop** key.

- The number of prints set in the counter are made and the machine stops.

7. Remove the prints from the paper delivery table.
  - If a large number of sheets is stacked in the paper delivery table (approximately 400 to 500), the leading edge of the paper tends to brush against this stack and may be stained by the ink on freshly printed sheets. Remove the paper from the paper delivery table before that happens.

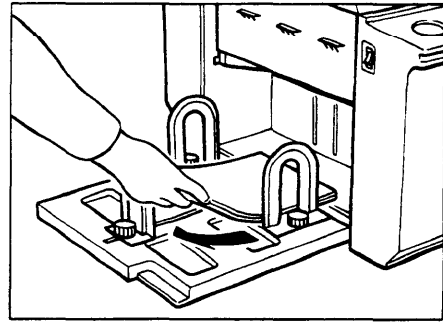

# Restoring The Paper Feed And Paper Delivery Tables

1. Turn off the main switch.

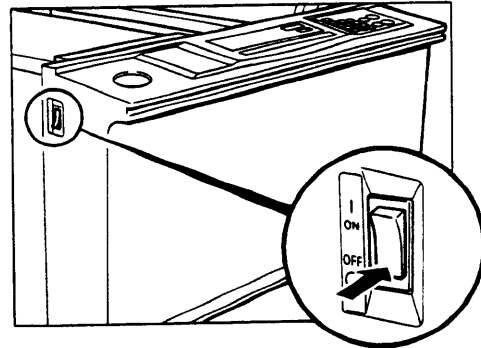

2. Press down the feed roller pressure lever.

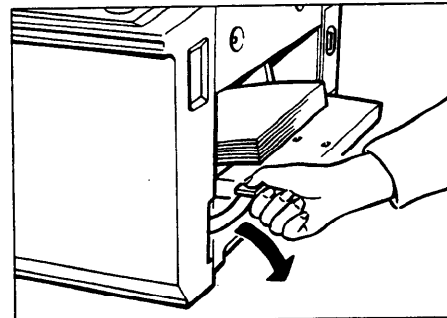

3. Remove the paper from the paper feed table.

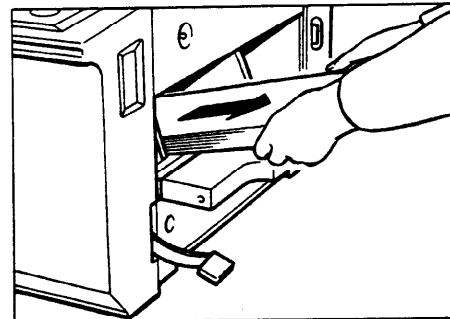

4. Lift the feed roller pressure lever, then return the paper feed table to its original position.

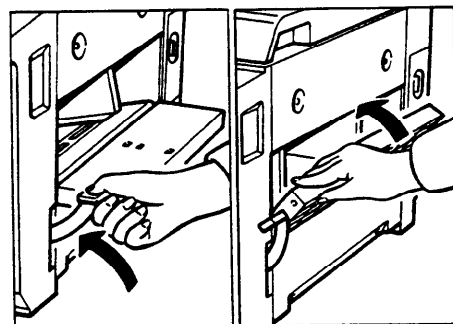

- 5. Move the paper delivery end plate to its original position.

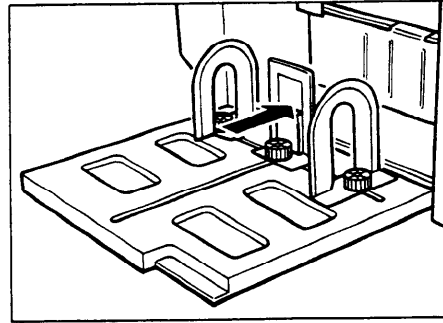

- 6. Return the paper delivery table and the original tray extender (if necessary) to their original positions.

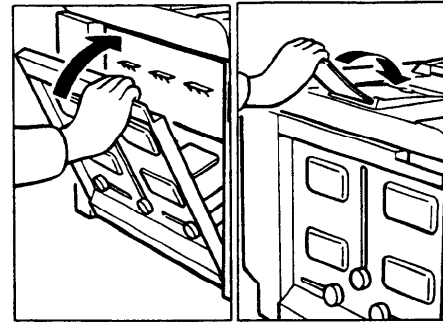



## Adjusting The Image Position

If the image position is not correct, adjust it before you start printing. Use the Image Position keys after you have made the master.

The left and right Image Position keys shift the image about 0.6 mm, 1/40" each time they are pressed. When the indicator changes, the image position shifts about 5 mm, 1/5".

### Shifting the image position forward or backward

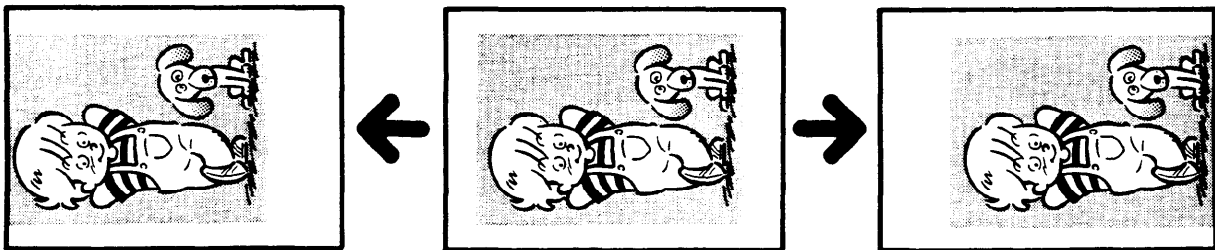

1. Press the right or left Image Position key.

- When you shift the image forwards, leave a margin (more than 5 mm, 1/5") at the leading edge. If there is no margin, paper may wrap around the drum and cause a misfeed.

2. Press the Proof key. Check the image position.

## Shifting the image to the right or left

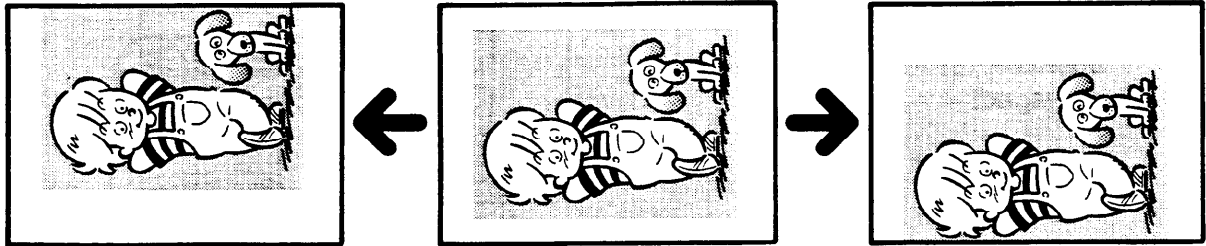

1. Press down the feed roller pressure lever.

- If you do not press down the feed roller pressure lever, the top sheet of paper may be misfed.

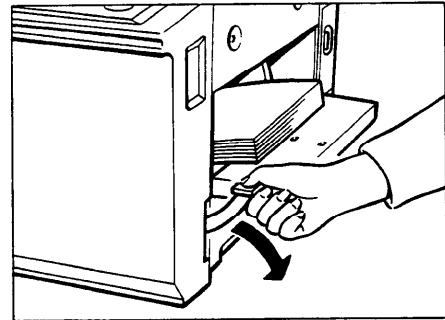

2. If the top sheet of paper is caught by the feed roller, remove the paper and reinsert it. Then, lift the feed roller pressure lever.

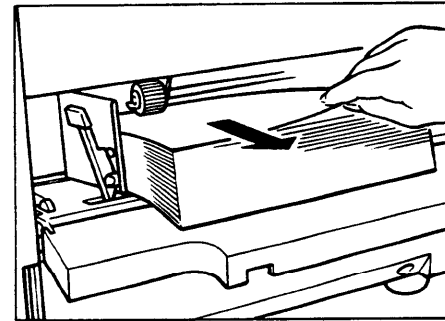

3. Turn the side plate fine adjustment dial as shown in the illustration.

- Before installing paper, make sure that the table is positioned in the center by referring to the indicator.
- The image position can be shifted up to 10 mm, 2/5" each way.

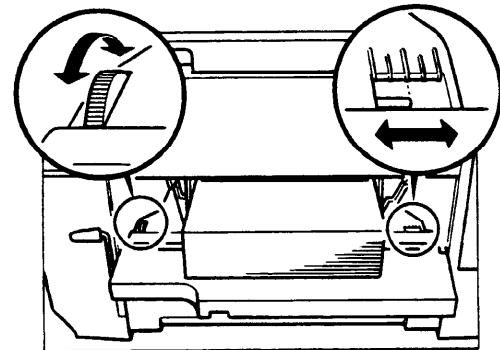

4. Adjust the paper delivery rollers to the print paper position.

*Caution: Do not touch the paper delivery rollers while the machine is operating, or the machine will be damaged.*

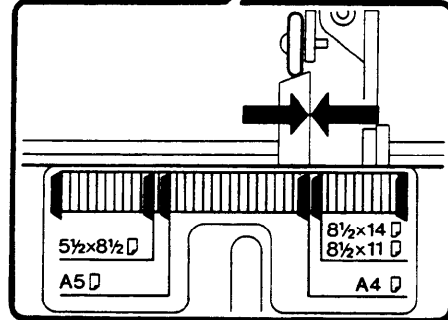
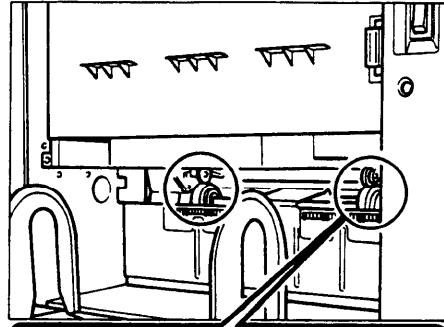

5. Adjust the paper delivery side plates to the print paper position. Then check the image position again.

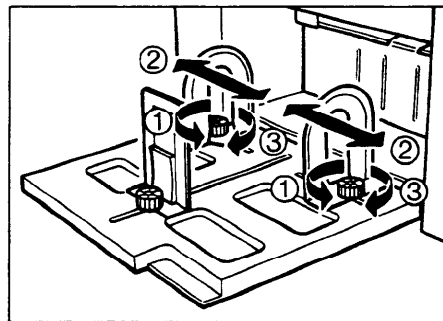

# Adjusting The Image Density

## Before you make a master:

Use the **Image Density** key before pressing the **Master Making** key.

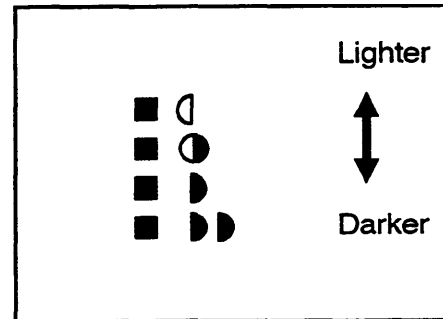

## After you make a master:

Press the **Speed** key. To increase the speed, press the "▶▶" key. To reduce the speed, press the "◀◀" key.

- The faster the printing speed becomes, the lighter the printing density is. If darker prints are required, decrease the printing speed.

## Changing The Printing Speed

Use the **Speed** key to adjust the rotation speed of the machine in accordance with the image density and printing paper.

Press the **Speed** key. To increase the speed, press the "▶▶" key. To reduce the speed, press the "◀" key. The printing speed will be changed as follows:

Setting 1	70 sheets/minute
Setting 2	100 sheets/minute
Setting 3	130 sheets/minute

When the main switch is turned on, setting 2 is selected automatically.

## To Stop The Machine During A Printing Run

If you want to stop the machine during a print run and print the next original, carry out the following procedure.

1. Press the **Stop** key.
2. Set the new original.
3. Re-enter the number of prints and press the **Master Making** key.

If you want to change the number of prints entered or if you want to check the completed prints.

1. Press the **Stop** key.

Change the number of prints or check the completed prints.

- To change the number of prints, re-enter the number using the **Number** keys after pressing the **Stop** key.

2. Press the **Print Start** key.

# Making Master And Prints Automatically

Use the **Auto Cycle** key to automatically process masters and make prints.

1. Enter the number of prints required using the **Number** keys.

2. Press the **Auto Cycle** key.

3. Insert the original face down on the original table until it stops.

- The stack should not exceed 6 sheets of normal thickness paper.
- The fed original may not be delivered completely from the ADF until the next original is fed.

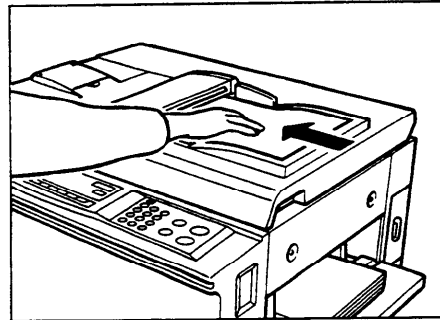

4. Press the **Master Making** key.

## Group Printing From The Same Original (Class Mode)

Use the **Memory/Class** key to make sets of prints from the same original. The same number of prints is made for each set.

- The optional tape dispenser automatically feeds out strips of paper which separate the printing groups on the paper delivery table.
- Up to 20 sets of prints can be selected for one original.

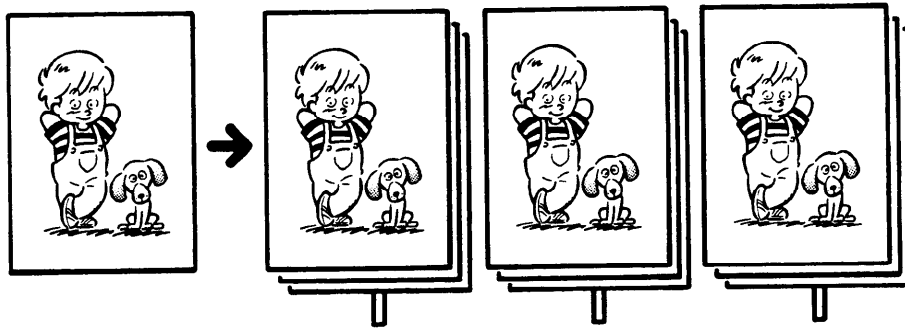

1. Press the **Memory/Class** key to light the "AAA" indicator.
2. Set the original face down on the original table.

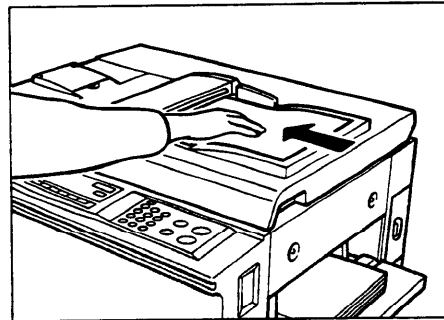

3. With the **Number** keys, enter the number of prints for each set to be made from the original.
4. Press the **Enter** key.



5. With the **Number** keys, enter the desired number of sets.

The maximum number of sets that can be made is 20.

6. Turn on the power switch of the tape dispenser (option).

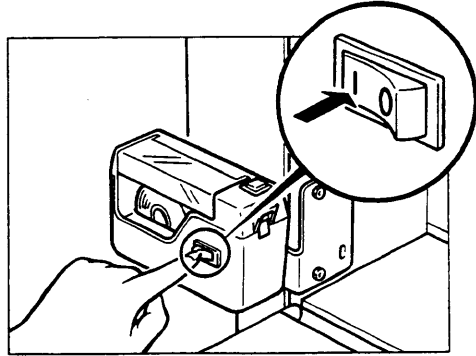

7. Press the **Master Making** key. Check the image position by making prints with the **Proof** key.

If the image position is not correct, adjust it using the **Image Position** key (See page 24) or the side plate fine adjustment dial (See page 25).

8. Press the **Print Start** key.

After the last page of each printing set is fed out to the paper delivery table, the tape dispenser drops a strip of paper onto the top of the paper stack. This marks the end of each printing group.

If the power switch of the optional tape dispenser is turned off or the tape dispenser is not installed in your machine, the group printing cycle stops after each group is finished. Remove the group from the paper delivery table and press the **Print Start** key to start the next group printing cycle.

# Group Printing From Different Originals (Memory Mode)

Use the **Memory/Class** key to make sets of prints from different originals.

- The optional tape dispenser automatically feeds out strips of paper which separate the printing groups on the paper delivery table.
- To prevent original misfeeds, do not set originals that are of different sizes.
- The stack should not exceed 6 sheets of normal thickness paper.
- The fed original may not be delivered completely from the ADF until the next original is fed in the ADF.
- When you use thin or coated originals, you cannot use the Memory mode.

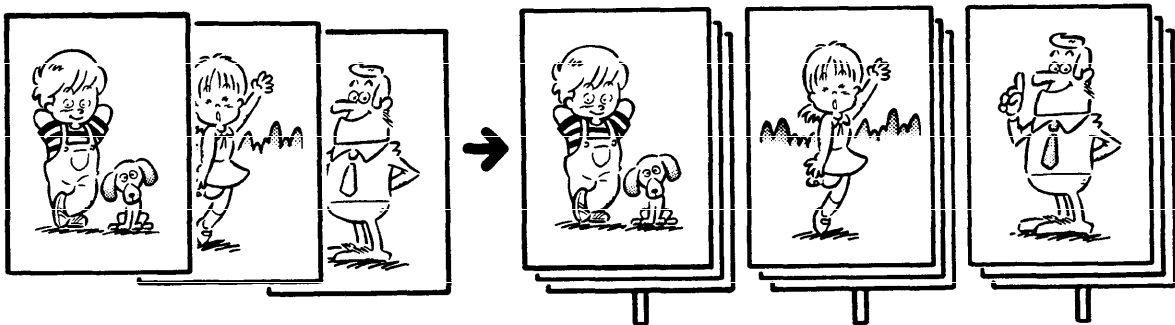

1. Press the **Memory/Class** key to light the "ABC" indicator.
2. With the **Number** keys, enter the desired number of prints for the first original.
3. Press the **Enter** key. This stores the number of prints to be made for the first original in Memory 1.
  - When the number of prints in each printing set is the same, it is not necessary to input the number of prints for each group in memory. Do not follow step 4 and 5. Follow step 6, 7, 8, 9 and 10.
4. With the **Number** keys, enter the number of prints for the second original.
5. Press the **Enter** key. This stores the number of prints to be made for the second original in Memory 2.
  - Repeat the above procedure for each original. The number of prints can be stored in memory for up to 6 originals.

6. Press the **Enter** key again. The memory returns to Memory 1.

- If you store the number of prints for 6 originals, the memory number returns to 1. It is not necessary to press the **Enter** key.

7. Set the originals face down on the original table.

- The originals are fed from the bottom of the stack. Make sure that the originals are set in the correct sequence with the first original (Memory 1) on the bottom.

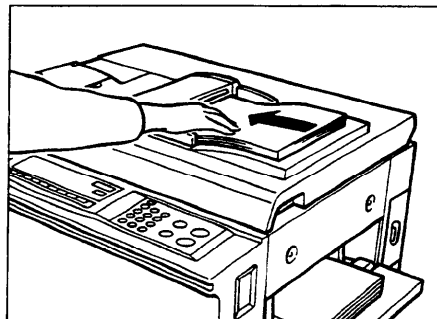

8. Press the **Master Making** key. Check the image position by making prints with the **Proof** key.

- If the image position is not correct, adjust it using the **Image Position** key (See page 24) or the side plate fine adjustment dial (See page 25).

9. Turn on the power switch of the optional tape dispenser.

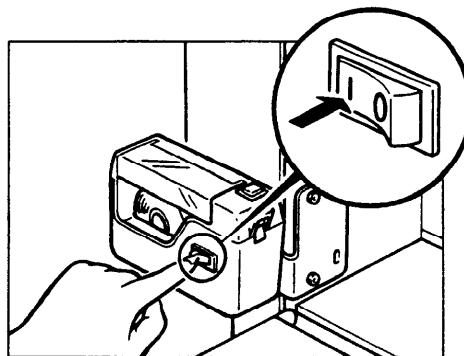

10. Press the **Auto Cycle** key.

- The Auto Cycle indicator will light.
- In the Auto Cycle mode, printing starts automatically after a trial print is delivered.

11. Press the **Print Start** key.

- After the last page of each printing set is fed out to the paper delivery table, the tape dispenser drops a strip of paper onto the top of the paper stack if you have the optional tape dispenser. The next group printing cycle begins automatically.

# Photo Mode Printing

**When printing a photograph or a color original, select the Photo mode.**

- Moire patterns may occur when screened originals are printed.
- If you make print in the Photo mode at low temperature, light and dark stripes may appear on the prints.

1. Press the **Image Mode** key to select the Photo mode.
2. Press the **Image Density** key to adjust the image density.
3. Follow the standard printing. See page 19.

---

# DAILY MAINTENANCE

## Thermal Head

Clean the thermal head after every second master roll. Otherwise, white lines may appear on the prints.

*Caution: When you open the top cover, make sure that there are no originals on the top cover.*

*Caution: If you drop something, such as a clip, inside the machine, remove it before continuing. If you cannot find what you have dropped or if you are unable to remove it from the machine, contact your service representative.*

1. Turn off the main switch and open the top cover.

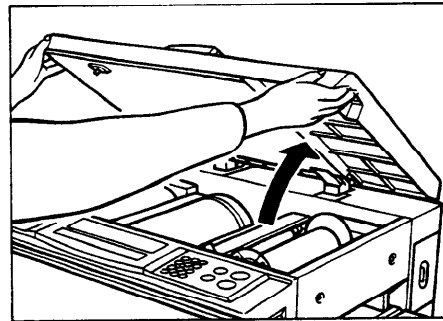

2. Move the pressure release lever in the direction of the arrow.

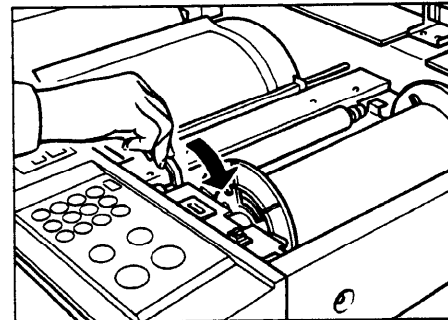

3. Remove the master roll.

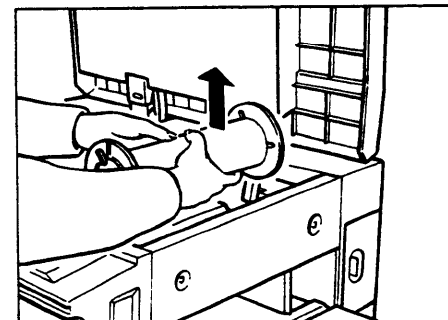

4. While pushing out the platen roller release levers (located on both sides of the feed roller), grip both ends of the feed roller and lift it straight up.

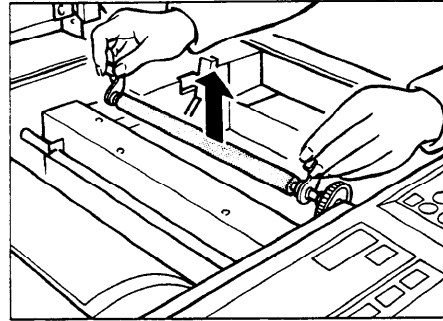

5. Clean the thermal head as follows:

- (1) Wipe the surface of the thermal head with a damp cloth.
- (2) Clean the surface of the thermal head several times using the cleaner pen with cleaning solution. (The cleaner pen is stored in the carton box as an accessory.)
- (3) Dry the surface of thermal head with a clean dry cloth.
  - Make sure to put the cap back onto the cleaning solution bottle.
  - Replace the felt of the cleaner pen if it becomes dirty.

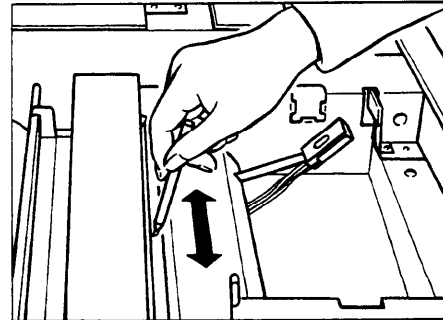

6. Grip the platen roller release levers, and put the feed roller back in its original position. While pushing the right platen roller release lever strongly until it is set completely, set the platen roller release levers in its original position.

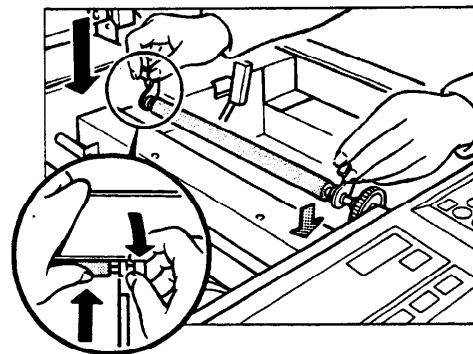

7. Place the master roll back in its original position. See page 6.

# Contact Glass

If you don't clean the contact glass, black lines may appear on prints.

1. Open the ADF cover.

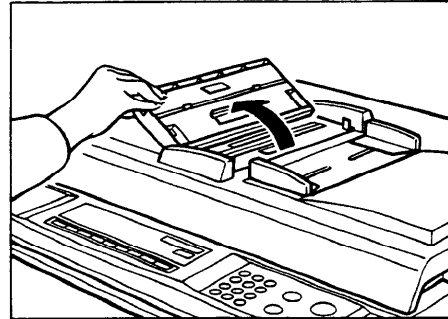

2. Wipe off the contact glass with a dry cloth.

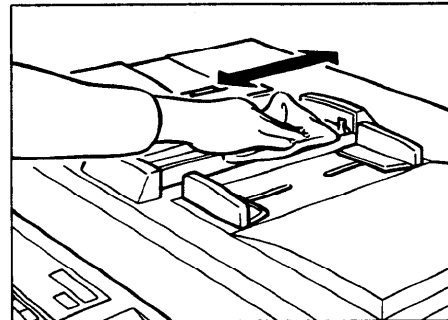

3. Close the ADF cover.
  - Make sure that the ADF cover is locked, both at the right and left sides.

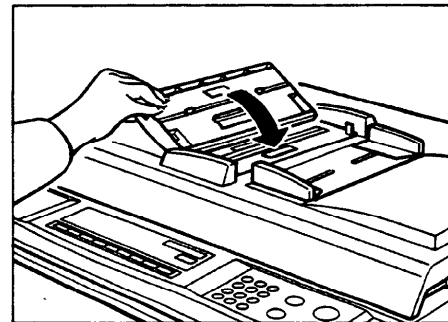

# Paper Feed Roller

If you don't clean the paper feed roller, the leading edge of the print may become dirty.

1. Open the paper feed table and press down the feed roller pressure lever.

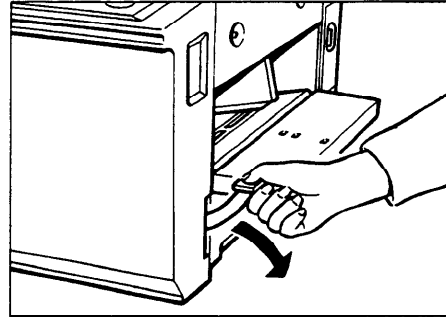

2. Wipe off paper dust on the paper feed roller with alcohol or cleaner.

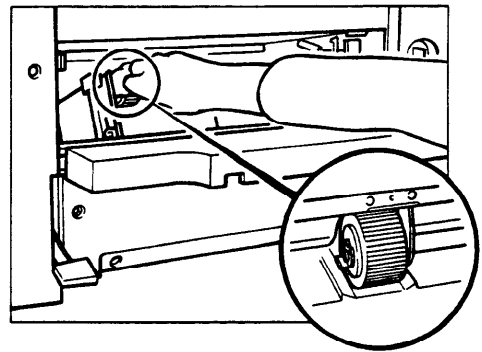



# Paper Delivery Rollers

If you don't clean the paper delivery rollers, black lines may appear on the prints.

1. Open the paper delivery table.

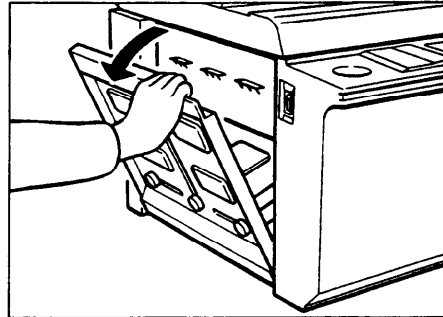

2. Open the top cover.

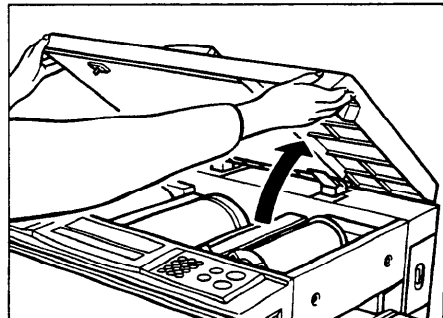

3. While rotating the drum manually, wipe the paper delivery rollers with alcohol or cleaner.

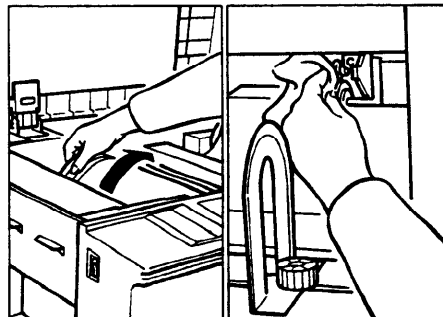

## Exit Sensor

If you don't clean the exit sensor, misfeeds may occur in the paper exit section.

1. Open the paper delivery table.

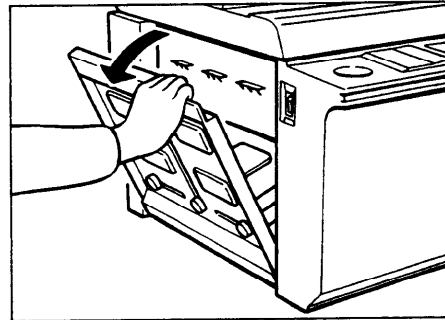

2. Wipe the exit sensor with a dry cloth.

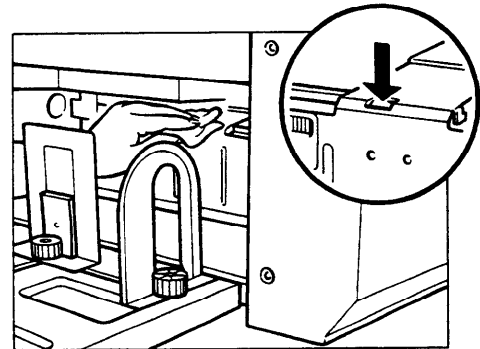

## Drum Clamper

If you don't clean the drum clamper, the master will not be set correctly around the drum and the image position may not be consistent during a long printing run.

1. Open the top cover.

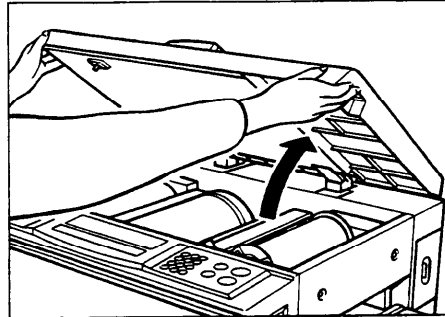

2. Wipe the drum clamper with a cloth damped with water.

*Caution: Never use alcohol or cleaner.  
Otherwise, the drum clamper will be damaged.*

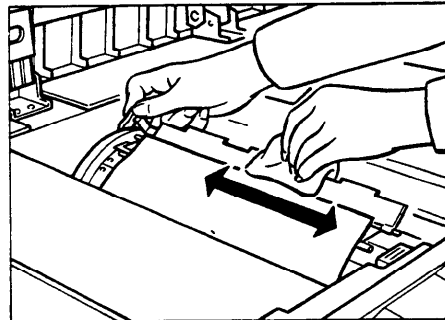

# TROUBLESHOOTING

If a malfunction or a misfeed occurs within the machine, the following indicators will blink or light.

## Monitors

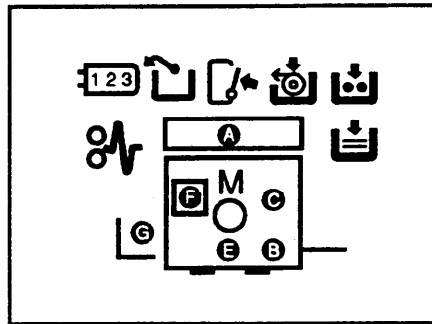

### When the Misfeed Indicator (⊗) Lights

MONITOR	MEANING	WHAT YOU SHOULD DO	PAGE
⊗ + A	Original Misfeed	Remove the original.	45
⊗ + B	Paper Feed Misfeed	Remove the misfed paper.	46
⊗ + C	Master Feed Misfeed	Remove the misfed master.	48
⊗ + E	Paper Wrap Misfeed	Remove the misfed paper.	49
⊗ + F	Master Eject Misfeed	Remove the misfed master.	51
⊗ + G	Delivery Misfeed	Remove the misfed paper.	53

### Clearing misfed paper, master, and original

**After removing misfed items, press the Reset key to reset error indicators. Do not turn off the main switch when removing the misfed items.**





#### Caution:

- When you open the top cover, make sure that there are no originals on the top cover.
- If you drop something, such as a clip, inside the machine, remove it before continuing. If you cannot find what you have dropped or if you are unable to remove it from the machine, contact your service representative.
- Remove misfed paper without tearing it. Remaining bits of paper will cause more misfeeds and may eventually cause a serious failure. If you tear the paper when removing it, make sure to remove all the torn pieces.

**When the Open Cover/Unit Indicator (☐/↔) Lights**

MONITOR	WHAT YOU SHOULD DO	PAGE
☐/↔	Close the cover.	54
	Close the paper delivery fence.	
	Set the master eject box.	
☐/↔ + A	Close the ADF cover.	

**When the Supply/Exchange Indicators Light**

MONITOR	WHAT YOU SHOULD DO	PAGE
	Load paper.	55
	Load a new ink cartridge.	
	Load a new master roll.	
	Empty the master eject box.	

**When Other Indicators Light**

MONITOR	MEANING	PAGE
M	Master not wrapped.	56
	Set the key counter.	
A	Set the original.	

## When The Misfeed Indicator (⚠) Lights

### " ⚠ + A " Original misfeed

1. Open the ADF cover.

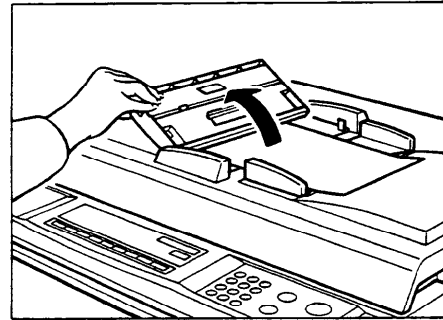

2. Pull out the original gently.

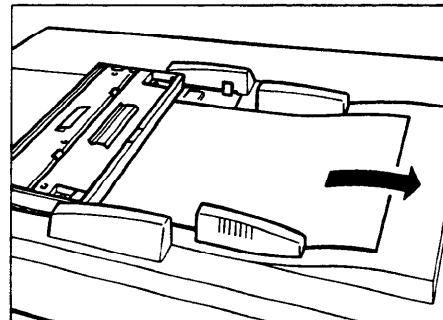

3. Close the ADF cover completely.
  - Make sure that the ADF cover is locked, both at the right and left sides.

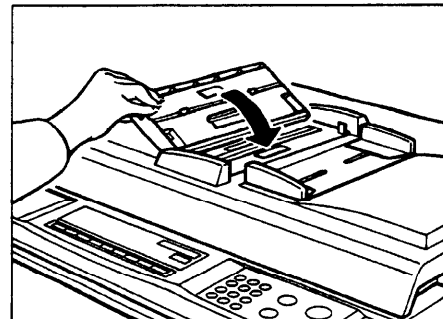

4. Press the **Reset** key.

#### To prevent original misfeed:

- Make sure that the ADF cover is closed.
- Do not stack more than 6 sheets of normal paper.
- Set the original straight.
- Push the original lightly when it is fed.

**" 8 1/2 " + B " Paper misfeed in paper feed section**

1. Push down the feed roller pressure lever.

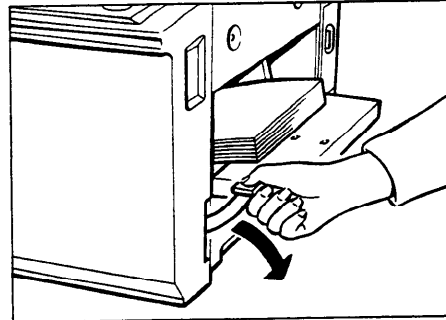

2. Remove the misfed paper.

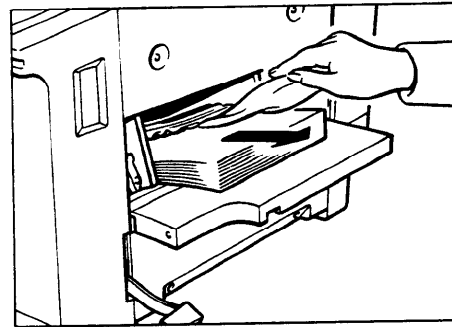

3. Lift the feed roller pressure lever.

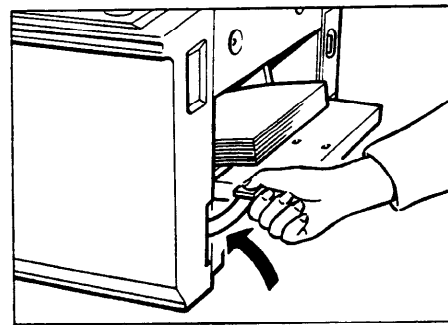

4. Press the **Reset** key.

**To prevent paper misfeeds:**

- Curled paper. → Correct the curl.
- Wrinkled or wavy paper. → Do not use such paper.
- Paper edges stuck together. → Shuffle the paper.
- Paper smaller than 210 x 150 mm, 8.3" x 5.9" and heavier than 150 g/m<sup>2</sup>, 39.9 lb paper. → Set the side pads. See page 16.
- Do not load more than 500 sheets of paper.
- Adjust the feed roller pressure when you use thick paper (heavier than 150g/m<sup>2</sup>, 39.9 lb).**

Push the pressure adjustment levers in, and then down.

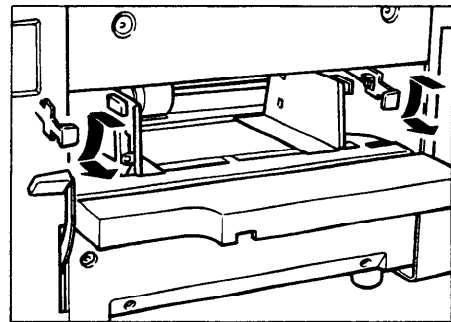



## " ♂ + C " Master misfeed in master feed section

**Warning:** *Be careful not to cut yourself on any sharp edges when you reach inside the machine to remove misfed sheets of paper.*

1. Open the top cover.

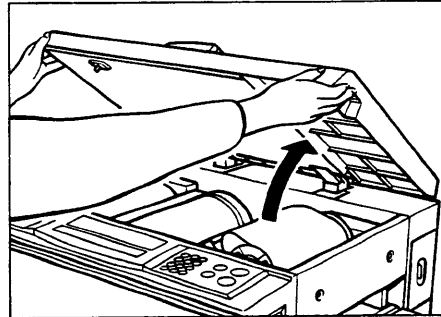

2. Lift the pressure release lever in the direction of the arrow and remove the misfed master.

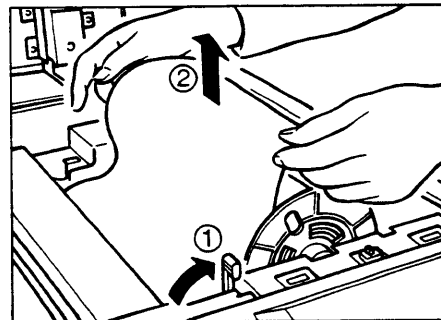

3. Reset the master roll. See page 6.

4. Close the top cover.

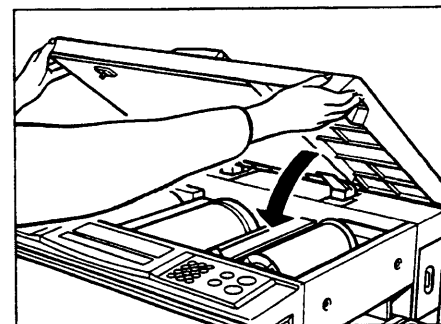

5. Press the **Reset** key.

## " $\circ\Lambda_V + E$ " Paper wrapping around the drum

**Warning:** Be careful not to cut yourself on any sharp edges when you reach inside the machine to remove misfed sheets of paper.

1. Open the top cover.

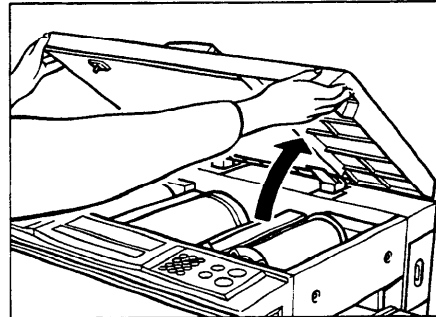

2. Peel the leading edge of the paper away from the drum. Then, remove the paper while rotating the drum manually.

- When you rotate the drum, be careful not to hit your hands against other parts of the machine.

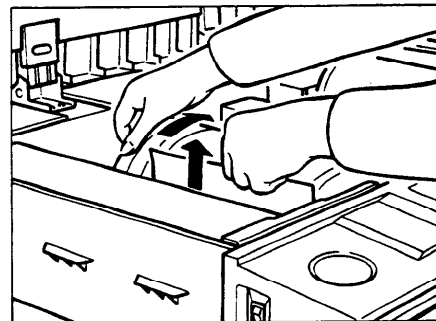

3. If you cannot find any paper, open the paper delivery fence. Then, remove the paper.

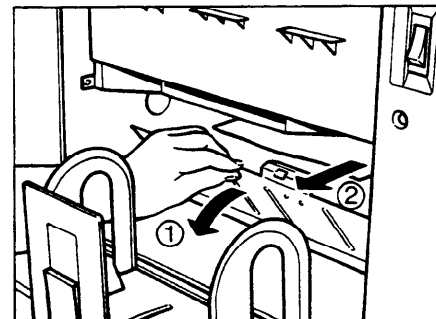

4. Close the paper delivery fence and top cover.

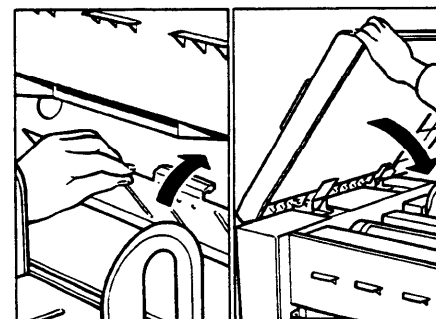

5. Press the **Reset** key.

**To prevent paper misfeed:**

- If there is a large solid fill image on the leading edge of original, set the original to have its leading edge become the trailing edge. Alternatively, change the image position and make a margin of more than 5 mm, 1/5" at the leading edge of prints.
- Try to change the printing speed.
- When you set a curled paper, correct the face curl of the leading edge of the paper as shown below.

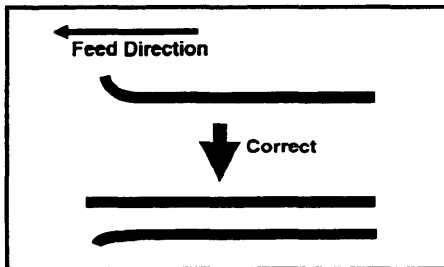

## " $\text{O} \Delta_V + F$ " Master misfeed in the master eject section. Master wrapped around the drum.

**Warning:** Be careful not to cut yourself on any sharp edges when you reach inside the machine to remove misfed sheets of paper.

When a master misfeed occurs in the master eject section.

1. Remove the master eject box.
  - Be careful not to drop the used master.

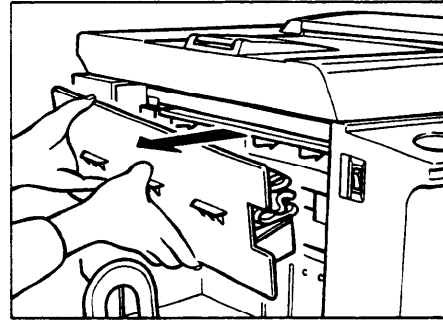

2. Grasp the leading edge of the misfed master and pull it out.

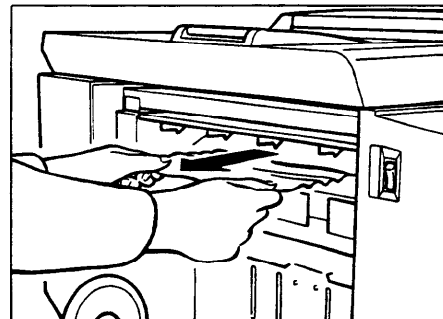

3. Reinstall the master eject box.

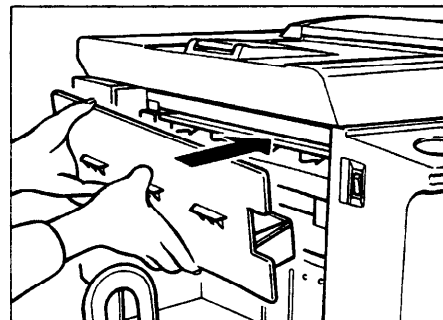

4. Press the **Reset** key.

**When a master misfeed occurs on the drum.**

1. Open the top cover.

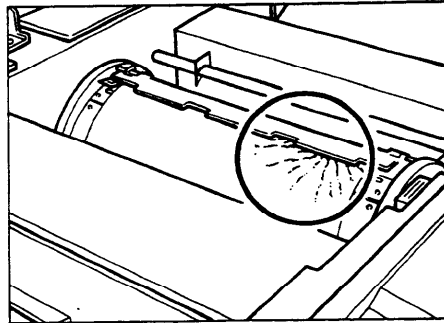

2. As shown in the illustration, open the drum clamber, and grasp the leading edge of the misfed master.

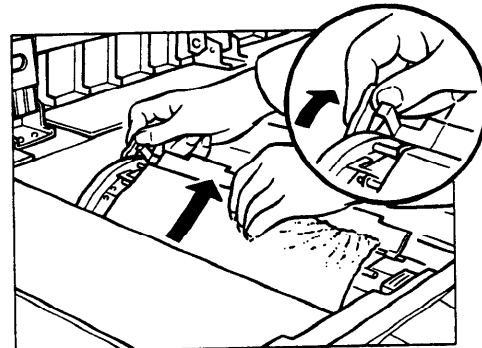

3. Remove the misfed paper while rotating the drum.

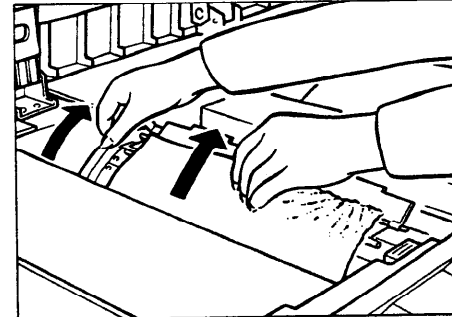

4. Close the top cover.

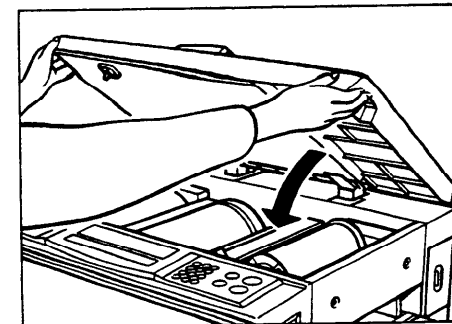

5. Press the **Reset** key.

## " ⌘ + G " Paper misfeed in the paper exit section

1. Remove the misfed paper.
  - Open the top cover or paper delivery fence if it is necessary.

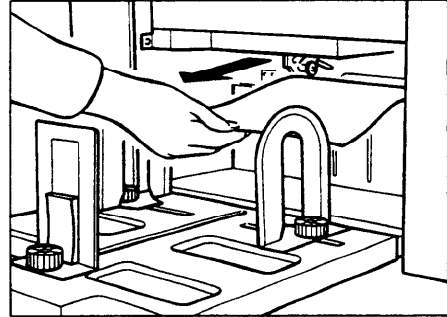

2. Press the **Reset** key.

### To prevent paper misfeed:

- Check the position of the paper delivery rollers. See page 18.
- If the exit sensor is dirty with paper dust, clean it. See page 41.
- If there is a large solid fill image on the leading edge of the original, set the original so that its leading edge becomes the trailing edge. Alternatively, change the image position and make a margin of more than 5 mm, 1/5" at the leading edge of prints.
- Try to change the printing speed.
- When you set a curled paper, correct the face curl of the leading edge of the paper as shown below.

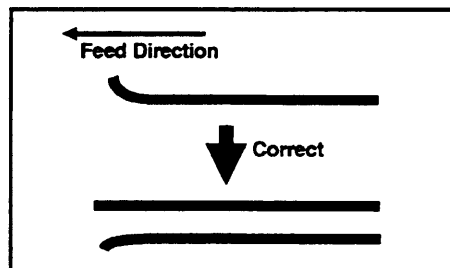

# When The Open Cover/Unit Indicator (☐↔) Lights

Make sure that the following covers and units are closed.

1. **Top cover**  
Close the top cover completely.

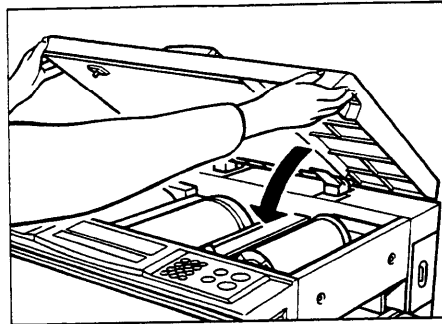

2. **Master eject box**  
Set the master eject box until it locks in position.

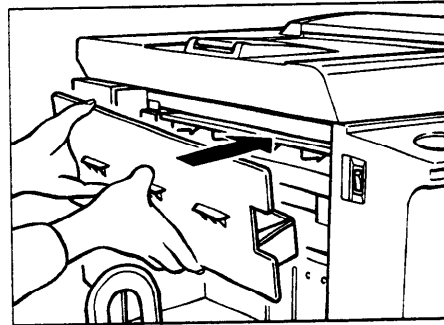

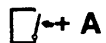
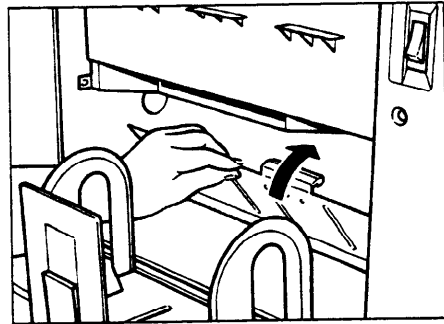

3. **Paper delivery fence**  
Close the paper delivery fence.

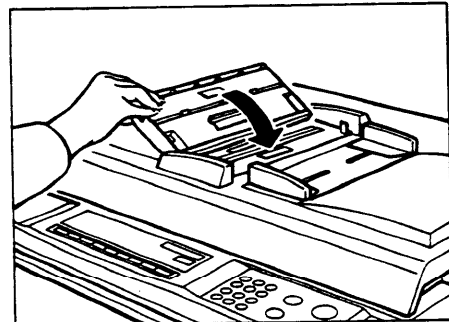

- ADF cover**  
Close the ADF cover completely, then press the **Master Making** key.



# When The Supply/Exchange Indicators Light

-  Load paper. See page 15.
-  Load new ink cartridge. See page 9.
-  Load new master roll. See page 6.

## Empty master eject box.

1. Take out the master eject box as shown.

Be careful not to drop the used masters.

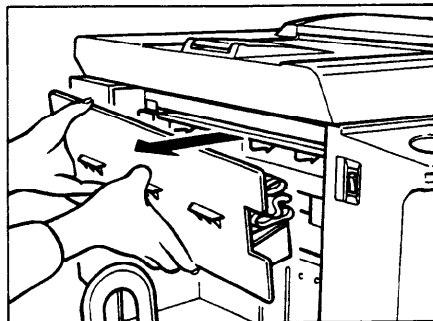

2. Remove the used masters.

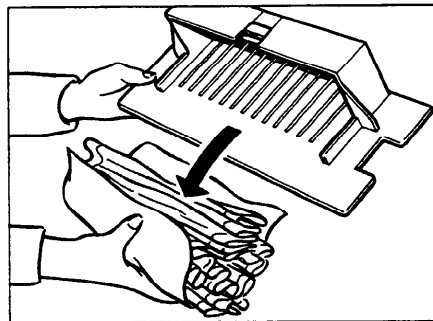

3. Reinstall the master eject box. Push it in until it locks in position.

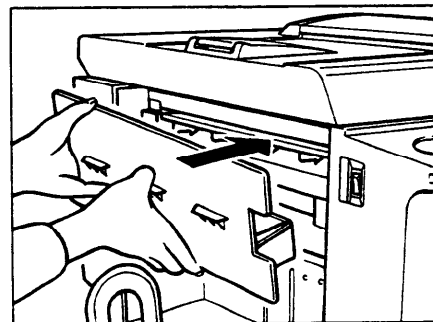

4. Press the **Reset** key.



## When Other Indicators Light

**M** — The master is not wrapped around the drum.

1. Open the top cover.

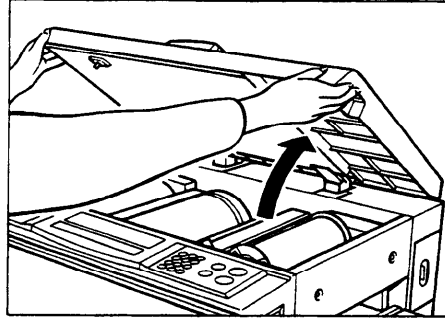

2. Make sure that there are no misfed masters inside the machine.

3. Close the top cover. Then, set the original in the ADF cover and press the **Master Making** key.

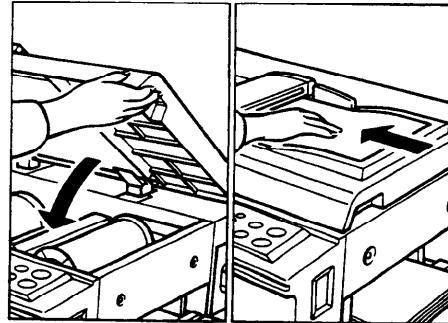

**123** — Set the key counter

The key counter (option) is not set. Insert the key counter.

**A** — Set the original

Set the originals in the ADF before pressing the **Master Making** key.

# Poor Printing

TROUBLESHOOTING

## Dirty background

If the background of prints are dirty, the press roller inside the machine is dirty. Make extra prints until the background of prints becomes clean.

- If you want to remove the press roller, contact your service representative.

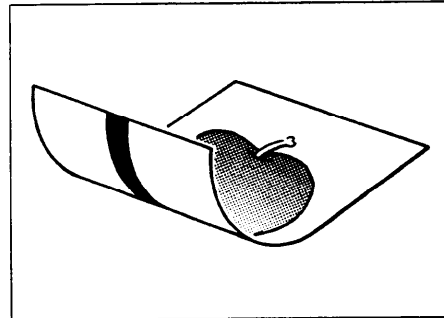

### To prevent dirty backgrounds:

- When you use paper smaller than originals. → Change paper or originals.
- When there is no margin on the leading edge of the originals. → Make a margin by pressing the **Image position** key.

## White lines/Black lines

Check the following parts and clean them if dirty.

- Contact glass (See page 38.)
- Thermal head (See page 36.)

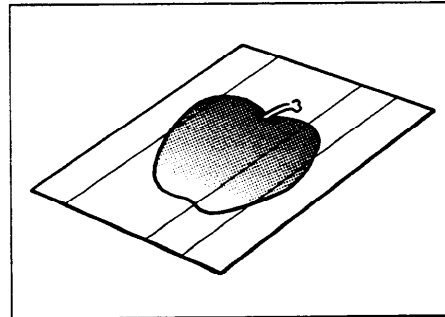

## OPERATION NOTES

- Make sure to make a few trial prints to check the image position because the image position of the trial print may not correspond with that of the original.
- The leading edge of the prints may become stained if the edge touches the image of the prints on the paper delivery table.
- When performing duplex printing, do not touch the printed paper for a while in order to let the ink on the printed paper dry. If this is not done, feed roller marks will appear on the print image.
- If the machine is not used for a long period, image density might decrease if the ink on the drum dries. Make extra prints until the image density recovers.
- If the machine is not used for a long period, the master may not be ejected automatically because ink on the drum dries. In this case, remove the master around the drum manually.
- The ink of the print on the paper delivery table might stick to the back side of the next print.
- Press the **Proof** key to make a test print, because the first few prints may be light. Especially in low temperature, you should make a few more test prints.
- As various kinds and qualities of paper exist, some paper might wrap around the drum or cause misfeeds.
- The image density varies according to the printing speed and the room temperature. In this case, adjust the printing speed or increase the room temperature.
- Depending on the paper size or image position, adjust the paper delivery rollers. When you use normal originals, leave 5 mm, 1/5" margins on the right and left sides of the paper. When you use dark originals, leave about 10 mm, 2/5" margins on both sides.

# CAUTIONS

## Operating Cautions

1. While Printing:
  - Do not turn off the main switch.
  - Do not unplug the power cord.
  - Do not open the cover.
  - Do not move the machine.
2. Keep corrosive liquids, such as acid, off the machine.
3. Do not allow paper clips, staples, or other small objects to fall inside the machine.
4. Always turn the machine off when you have finished printing for the day.
5. Do not touch print paper if your fingers are wet or oily; fingerprints may appear on prints.

## General Cautions

1. Do not modify or replace any parts other than the ones specified in this manual.
2. When the machine will not be used for long periods, disconnect the power cord.
3. If the machine must be transported by vehicle, please contact your dealer.
4. When the machine is transported, make sure that the paper delivery table is closed and never hold the machine by the delivery table handle. Hold the machine by the handle that is located at the bottom.

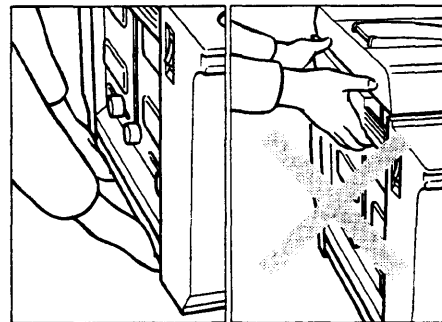

5. Be careful not to pinch your fingers between the paper delivery table and the bottom of the machine.

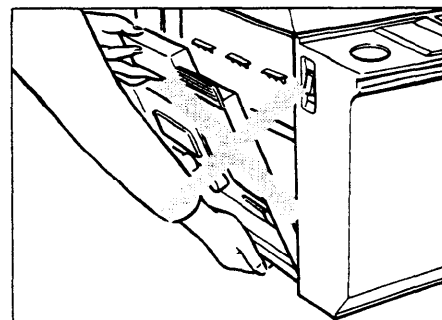

## CAUTIONS

---

6. Do not operate the machine with any covers off.
7. Be careful not to cut yourself on any sharp edges when you reach inside the machine to remove misfed sheets of paper.
8. Do not use thermal head cleaner for anything but cleaning the thermal head. Be careful as this cleaner is flammable. Take note of the following cautions regarding the cleaner:
  - ☞ Do not ingest.
  - ☞ Do not inhale the cleaner's fumes.
  - ☞ Keep out of the reach of children.
  - ☞ If cleaner comes in contact with your skin, wash well with water.
  - ☞ Keep away from your eyes. If cleaner comes in contact with your eyes, wash well. If irritation occurs, contact a doctor.
  - ☞ Never place cleaner where it will be exposed to heat.
9. If your hands are stained with ink:
  - ☞ Avoid prolonged or repeated contact with your skin.
  - ☞ Cleanse your skin thoroughly after contact, before breaks and meals, and at the end of your work period.
  - ☞ Ink is readily removed from skin by waterless hand cleaners, followed by washing with soap and water.

Also, be careful not to get any ink on your clothing while emptying the master eject box or while loading a new ink cartridge.

---

# SPECIFICATIONS

<b>Configuration:</b>	Desk top
<b>Printing Process:</b>	Full automatic one drum stencil system
<b>Original Type:</b>	Sheet
<b>Original Weight:</b>	64 g/m <sup>2</sup> ~ 104.7 g/m <sup>2</sup> , 17.0 lb ~ 27.9 lb
<b>Image Mode:</b>	Line/Photo
<b>Original Size:</b>	Max: 216 mm x 356 mm, 8.5" x 14.0" Min: 90 mm x 140 mm, 3.5" x 5.5"
<b>Paper Size:</b>	Max: 216 mm x 356 mm, 8.5" x 14.0" Min: 90 mm x 140 mm, 3.5" x 5.5"
<b>Paper Weight:</b>	70 g/m <sup>2</sup> ~ 200 g/m <sup>2</sup> , 18.6 lb ~ 53.2 lb
<b>Printing Area:</b>	210 mm x 349.6 mm, 8.3" x 13.8" or less
<b>Print Speed:</b>	70/100/130 cpm (3 settings)
<b>First Print Time:</b>	30 seconds ± 2 seconds
<b>Leading Edge Margin:</b>	5 ± 2 mm, 0.2" ± 0.08"
<b>Trailing Edge Margin:</b>	1 ± 1 mm, 0.04" ± 0.04"
<b>Left Side Margin:</b>	5 ~ 10 mm, 0.2" ~ 0.4"
<b>Right Side Margin:</b>	5 ~ 10 mm, 0.2" ~ 0.4"
<b>Paper Feed Table Capacity:</b>	500 sheets (80 g/m <sup>2</sup> , 20.0 lb)
<b>Paper Delivery Table Capacity:</b>	500 sheets (80 g/m <sup>2</sup> , 20.0 lb)
<b>Master Eject Box Capacity:</b>	15 masters
<b>ADF Original Capacity:</b>	6 sheets or a 0.6 mm height

**SPECIFICATIONS**

**Weight:** 51 kg, 112 lb

**Power Source:** 120V 60Hz more than 2.4A

**Power Consumption:** Master Making: less than 0.16 kW  
 Printing: less than 0.16 kW

**Dimensions:** [Stored] 692 mm x 612 mm x 440 mm  
 (W x D x H) 27.2" x 24.1" x 17.3"  
 [Set up] 1050 mm x 612 mm x 440 mm  
 41.3" x 24.1" x 17.3"

**Noise Emission:** Less than 70 dB  
 (Sound pressure level\*) Master Making: 54dB  
 \* = The measurements are to be made according to ISO7779. Printing: 70 cpm: 62 dB  
 100 cpm: 64 dB  
 130 cpm: 68 dB

**Optional Equipment:** Key Counter, Tape Dispenser

**Consumables:**

Name	Size	Remarks
Thermal master	Length:125 m, 410 ft/roll Width: 240 mm, 9.5"	255 masters can be made per roll. Storage -10 ~ 40 °C, 10 ~ 90 %RH
Ink	500 cc/pack	Environmental conditions: -5 ~ 40 °C, 10 ~ 90 %RH
Tape for tape maker	35 m, 114.8 ft/roll	
Thermal head cleaner	Cleaner pen – 1pc Replacement felt – 10 pcs Cleaner bottle – 1pc	Clean the thermal head using the cleaner when 2 master rolls have been used.

Specifications are subject to change without notice.